

Seeking new opportunities for South and North Korean health and medical cooperation in the international infectious disease crisis

Jong-koo Lee MD, MPH, PHD
Ambassador for Global Health Security
Former Professor of SNUMC
Former Director of KCDC

Situation will be better(1)?

Global total case
559,469,605

Global total death
6,361,157

SEAR total case
59,014,359

SEAR total death
791,302

Country - Confirmed cases (deaths)

India	- 43,783,062 (525,785)
Indonesia	- 6,143,431 (156,865)
Thailand	- 4,562,968 (31,031)
Bangladesh	- 1,997,412 (29,241)
Nepal	- 982,062 (11,954)
Sri Lanka	- 664,572 (16,531)
Myanmar	- 613,855 (19,434)
Maldives	- 183,908 (307)
Bhutan	- 60,109 (21)
Timor-Leste	- 22,980 (133)

DPR Korea Fever cases (deaths)
 Cases in the last 24 hours - **3,10 (0)**
 Cumulative cases - **4,771,600 (74)**
 (source: *KCNA*, as of 18:00 July 17, 2022)

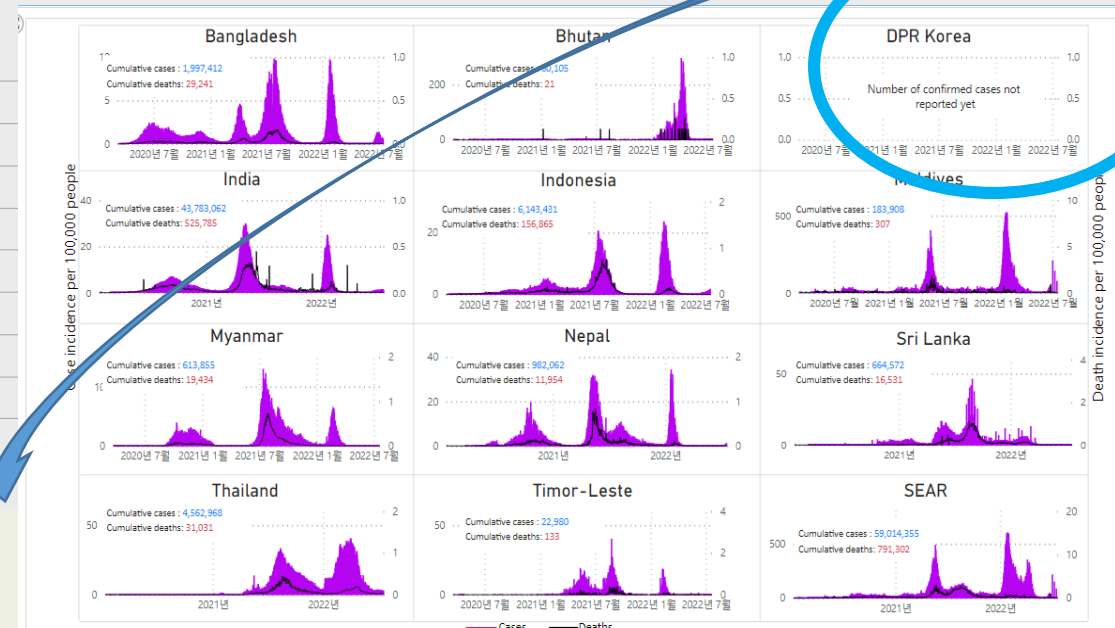

2022-07-21

Situation will be better(2)?

Daily new fever cases and recoveries

State media data to 6pm each day

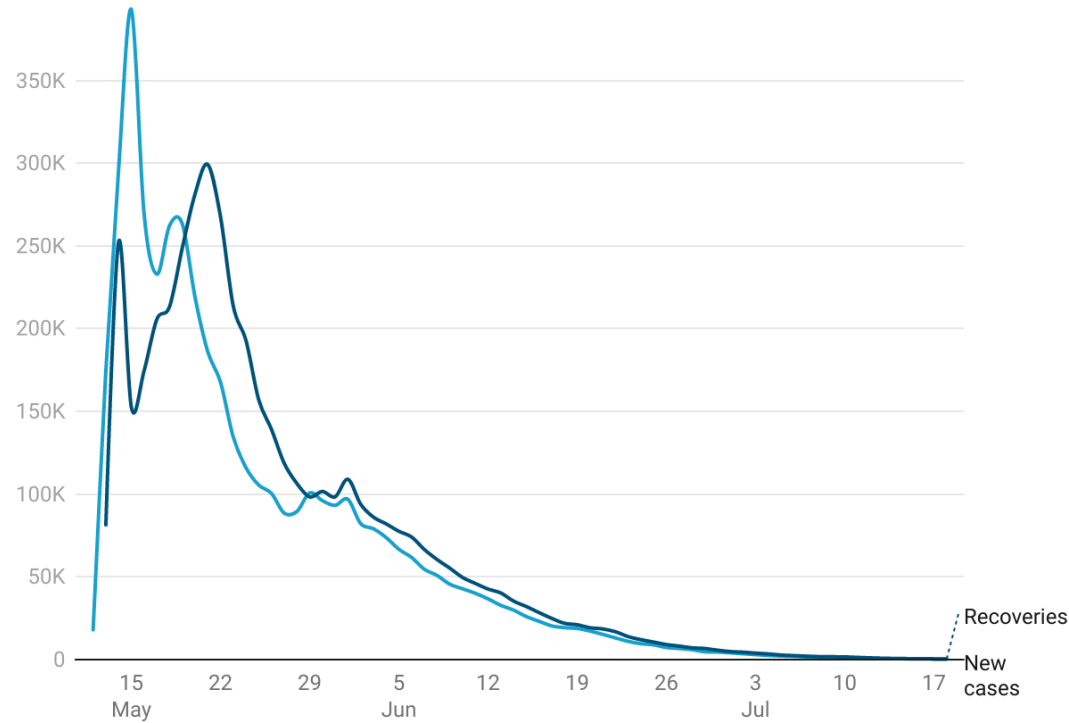

Chart: 38 North / Martyn Williams • Source: Korean Central News Agency • Created with Datawrapper

Number of Active Cases

Daily total of active cases of fever

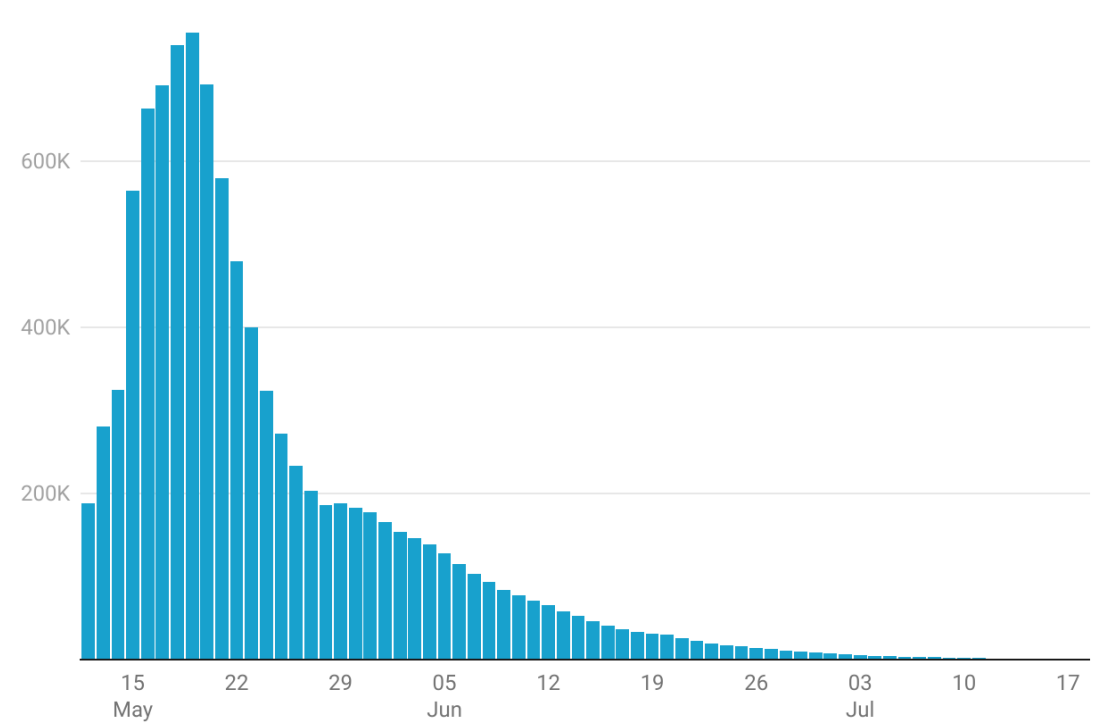

Chart: 38 North / Martyn Williams • Source: Korean Central News Agency • Created with Datawrapper

Situation will be better(3)?

Daily Deaths

Number of deaths reported in the 24 hours to 6pm on the day noted

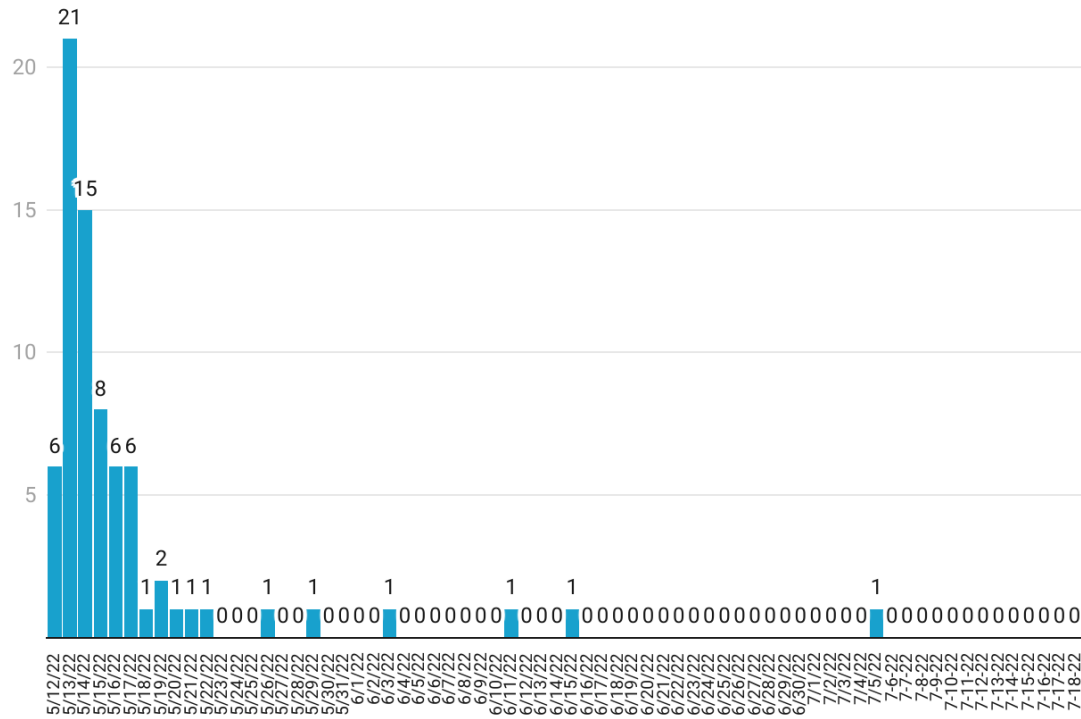
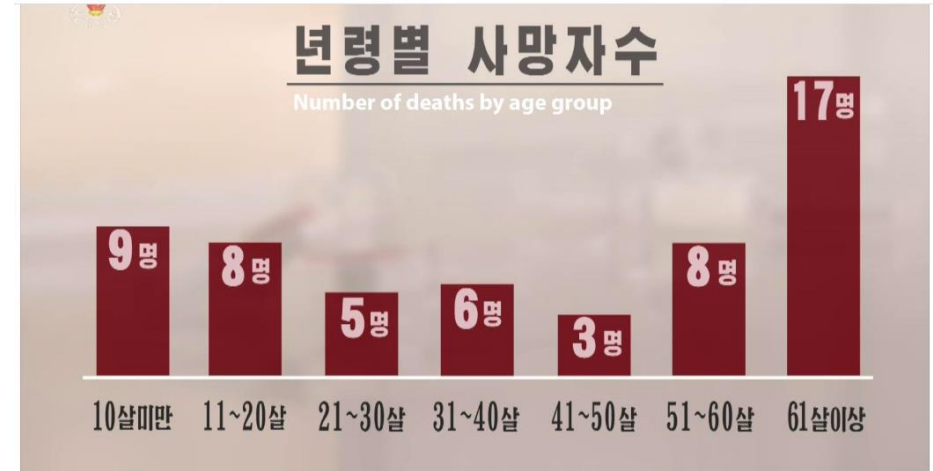
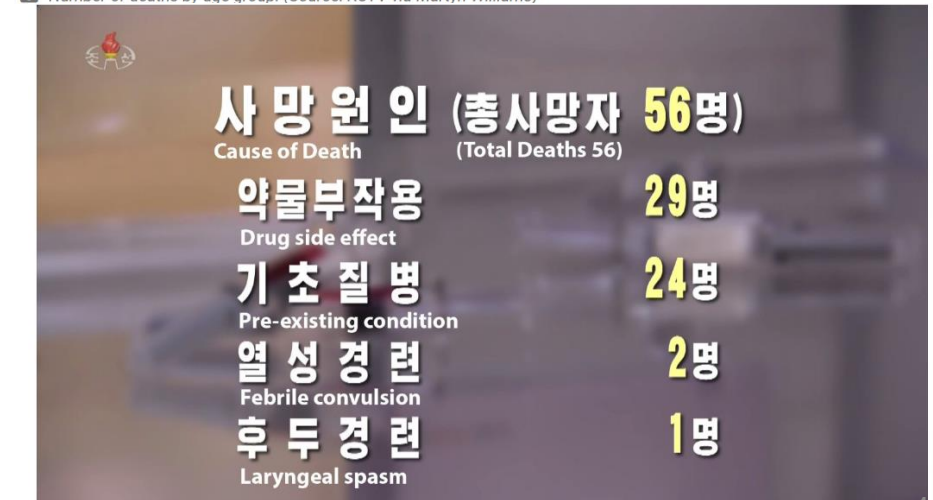

Chart: 38 North / Martyn Williams, Iliana Ragnone • Source: Korean Central News Agency • Created with Datawrapper



Number of deaths by age group. (Source: KCTV via Martyn Williams)



Cause of death and death total. (Source: KCTV via Martyn Williams)

PCT test Capacity

Daily new COVID-19 tests

Comparisons across countries are affected by differences in testing policies and reporting methods



Source: Official data collated by Our World in Data

CC BY

Daily COVID-19 tests per thousand people

7-day rolling average. Comparisons across countries are affected by differences in testing policies and reporting methods.

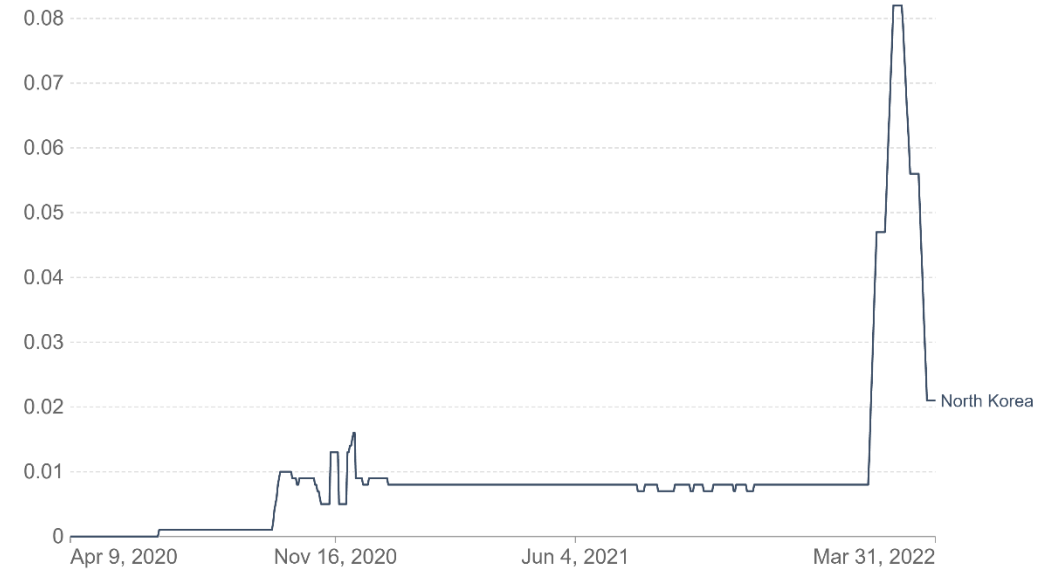

Source: Official data collated by Our World in Data – Last updated 23 June 2022

Note: Our data on COVID-19 tests and positive rate is no longer updated since 23 June 2022.

OurWorldInData.org/coronavirus • CC BY

Intervention Situation

Vaccination

- No data
- **66.8%** of the world population has received at least one dose of a COVID-19 vaccine.
- **12.23 billion doses** have been administered globally, and **4.43 million** are now administered each day.
- Only **19.4%** of people in low-income countries have received at least one dose.

Stringent index

- No data : but NPIs

COVID-19: Stringency Index

The stringency index is a composite measure based on nine response indicators including school closures, workplace closures, and travel bans, rescaled to a value from 0 to 100 (100 = strictest).

Our World in Data

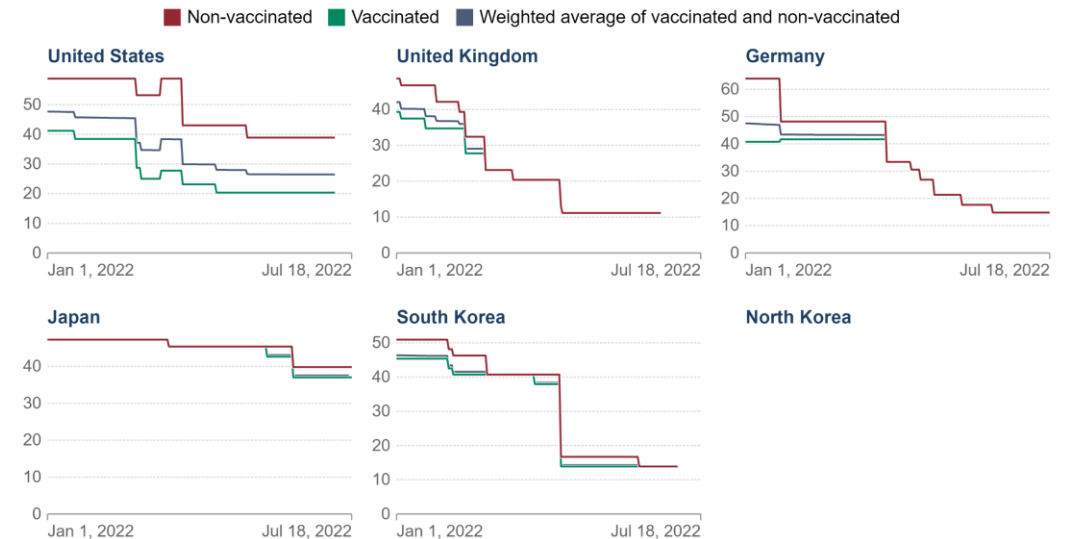

Source: Hale, T., Angrist, N., Goldszmidt, R. et al. A global panel database of pandemic policies (Oxford COVID-19 Government Response Tracker). Nat Hum Behav 5, 529–538 (2021). <https://doi.org/10.1038/s41562-021-01079-8>
CC BY

Criteria of Release of Emergency

Covid in North Korea is likely 'getting worse, not better': WHO

Story by Reuters

Updated 0358 GMT (1158 HKT) June 2, 2022

North Korea claims Covid arrived on 'alien things' near border

By Leo Sands
BBC News

BREAKING Zelenskyy says he has dismissed a deputy head of Ukraine's security service

News | Coronavirus pandemic

North Korea says nearing end of COVID crisis

The isolated country's claim comes as Asian neighbours are battling a new wave of infections driven by Omicron subvariants.

2022-07-21

- (1) the possibility of an infectious disease entering from abroad is **completely eliminated**,
- (2) an infectious disease can be **effectively dealt with**.
- (3) **the risk** to the lives and safety of the people is **completely eliminated** from the infectious disease that has occurred inside DPRK

Scenarios of Outbreak, DPRK

Best

- Successful Zero-COVID policy
 - July 17; 310

Worst

- BA.2. << BA.4., BA.5, endemic
- New variant BA.2.75

Number of Active Cases

Daily total of active cases of fever

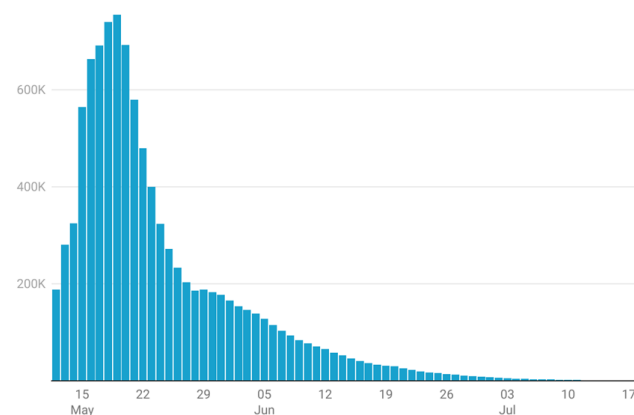

Chart: 38 North / Martyn Williams • Source: Korean Central News Agency • Created with Datawrapper

Global Goods and Addressing Inequity

COVID-19 Tools (ACT) Accelerator



Diagnostics pillar, co-convened by [FIND](#) and the [Global Fund](#), with support from UNITAID, UNICEF and WHO

Therapeutics pillar, co-convened by [Wellcome](#) and [UNITAID](#), with support from WHO, UNICEF and the Global Fund

Vaccine, **COVAX**, led by [CEPI](#), [Gavi](#) and [WHO](#) and implementing partner [UNICEF](#)

Health System Strengthening connector, led by the [World Bank](#), [Global Fund](#) and [WHO](#)

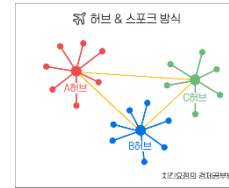

Hub & Spoke Model

- Africa, Asia, America-

Small/middle-sized (public or private) **manufacturers of medical products** (*drugs, vaccines or drug substances*) in LMICs, which could host a COVID-19 mRNA hub

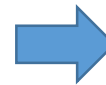

Owners (public or private) of technology and/or intellectual property rights. willing to contribute these to a **technology transfer hub**, under the auspices of WHO

Cooperation Sectors

Sector 1 (Quarantine, Contact Tracing, Testing, ITC)

Sector 2 (Patient Care, HW Edu/Training), Telemedicine

Sector 3 (surveillance, Research, epi data, Dx, Tx, Vaccine R&D)

Sector 4 (PPE, ventilator, drug & vaccine production)

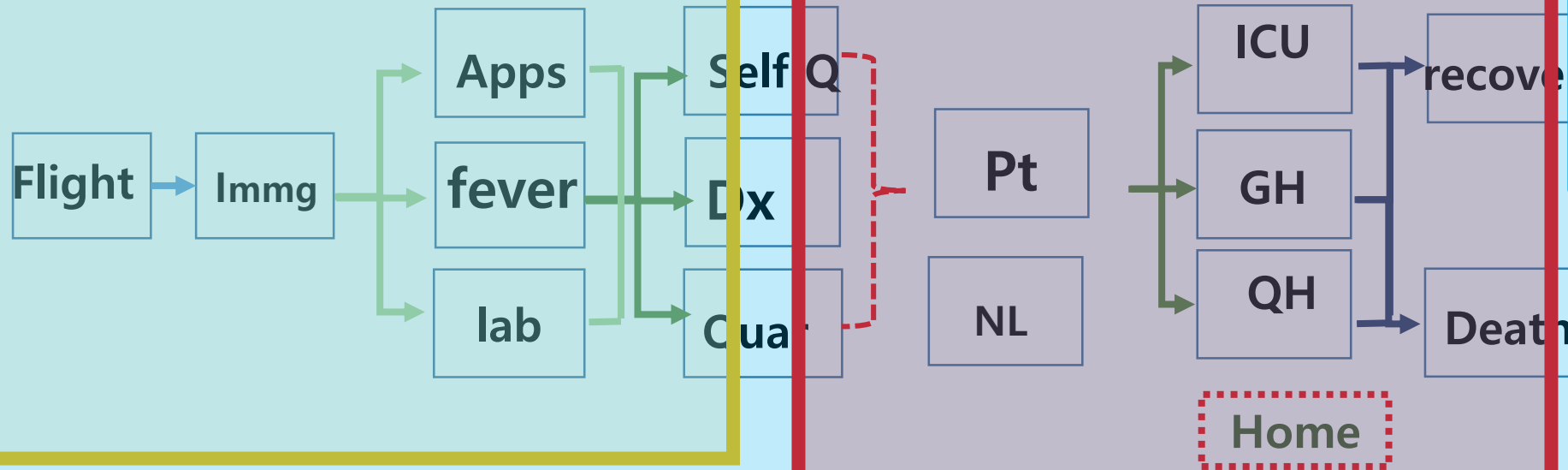

In Short Term; Humanitarian Emergency Aid

- 1, 2, 4 sector or 3 sector
- ***Indirect support of infectious disease control products through China and the WHO.***
 - In addition, ROK is conducting ***Asia pacific region vaccine-related education programs*** in cooperation with WHO and ADB. In this education, DPRK technicians are invited to help improve vaccine capabilities in their own country
 - and also will invite DPRK to ***World BIO Summit 2022*** on October
- ***Vaccines*** produced in South Korea will be rolled out through the ***COVAX facility*** in cooperation with WHO support to North Korea
 - support for ***basic medical supplies through private NGOs, universities, and hospitals,*** will be effective, and revitalization of medical personnel education program also important

In Mid Term;

- Sector 3, 4
- There will be a way to indirectly help North Korea by having North Korea participate in the WHO's *mRNA vaccine transfer hub and spokes project* in Asia.
- The ROK government envisioned and promoted the '**Cooperation System for Pandemic in Northeast Asia**,' including Russia and Mongolia, by expanding the existing system by exchanging information and sharing information with the Korea, China and Japan Ministerial Meeting established in 2007 and infection control agencies. To support this, an '*academic forum*' plan such as education, and research between academics from universities and research institutes

In Long Term;

- Lastly, since the European and African CDCs have been established, it will be necessary to consider long-term measures to establish ***a multilateral cooperation system*** with both DPRK and ROK participating in the establishment of this ***new international organization in Asia region*** related to infectious diseases control.

Covid-19 pandemic will not be the last

-----Dec 27, 2020,

Tedros A Ghebreyesus, DG WHO

*We will move forward towards
the goal of Health for All,
Together, learning from the past,
we can change
the future of global public health
- LEE Jong-wook(late DG WHO)*

